



User Manual

Refrigerator-Freezer

HRF450BW2

HRF450BS2

HRF450BHS2

HRF450BHC2

Haier



0060529687

Haier

Thank you for purchasing a Haier Product.

Please read these instructions carefully before using this appliance. The instructions contain important information which will help you get the best out of the appliance and ensure safe and proper installation, use and maintenance.

Keep this manual in a convenient place so you can always refer to it for the safe and proper use of the appliance.

If you sell the appliance, give it away, or leave it behind when you move house, make sure you also pass this manual so that the new owner can become familiar with the appliance and safety warnings.

Legend

Warning – Important Safety information



General information and tips



Environmental information



Disposal

Help protect the environment and human health. Put the packaging in applicable containers to recycle it. Help to recycle waste of electrical and electronic appliances. Do not dispose appliances marked with this symbol with the household waste. Return the product to your local recycling facility or contact your municipal office.



WARNING!

Risk of injury or suffocation!

Refrigerants and gases must be disposed of professionally. Ensure that the tubing of the refrigerant circuit is not damaged before being properly disposed of. Disconnect the appliance from the mains supply. Cut off the mains cable and dispose of it. Remove the trays and drawers as well as the door catch and seals, to prevent children and pets to get closed in the appliance.

Intended Use.....	5
Safety.....	6
Product Description.....	10
Use.....	12
Equipment.....	22
Care and Cleaning.....	24
Troubleshooting.....	26
Installation.....	29
Technical Data.....	33

Trade mark	Haier
Model No.	HRF450BW2 HRF450BHS2 HRF450BS2 HRF450BHC2
Category of the model	Refrigerator-freezer
Voltage / Frequency	220V-240V~/50Hz
Energy Star	4 star
Frostfree system	Yes
Product group	5B
Total gross volume	454L
Total storage volume	405L
Fresh food compartment volume	311L
Freezer compartment volume	94L
Climate class	T
Rrefrigerant	R600a 70g
Insulation blowing gas	HC-C601
Dimension (DxWxH)	676×700×1725mm
Protection class	I

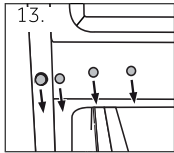

13. Change the positions of the blanking plugs and the screw on the side.

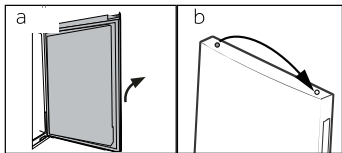

a Remove lower door
b Change the positions of the blanking plug at the top of the lower door.

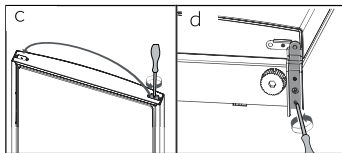

c Change the door stop at the bottom of the lower door from the current position to opposite side
d Unscrew the lower hinge

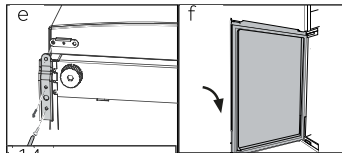

e Take out the new lower hinges from the accessory bag and screw the new lower hinge to the other side of the door opening
f Lift the lower door carefully on to the lower hinge so that the pivot fits into the hinge barrel.

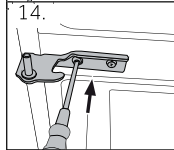

14. Take out the new hinges from the accessory bag and screw the new lower hinge of upper door to the other side of the door opening.

Be sure the pivot fits into the hinge barrel of lower door.

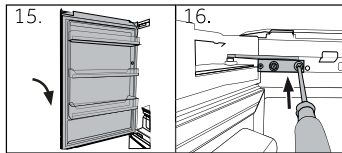

15. Lift the door carefully on to the lower hinge so that the pivot fits into the hinge barrel.
16. Fix the upper hinge with the screws.

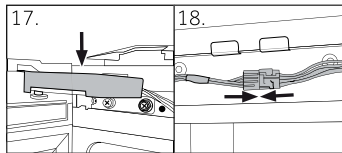

17. Put the connection cable through the hinge cover (delivered in the accessory bag) and put it over the hinge.
18. Plug in the connection cable and fit it into the opening.

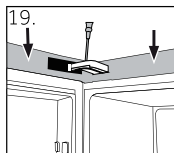

19. Replace faceplate and cover, fix it with the screws and reinsert the fixation (see fig. 3).

After the change of the door check that the door seals are located properly on the housing and all screws are tightened well.

Intended use

This appliance is intended for cooling and freezing food. It has been designed exclusively for use in dry-interior house-holds. It is not intended for commercial or industrial use.

Changes or modifications to the device are not allowed. Unintended use may cause hazards and loss of warranty claims.

Accessories

Check the accessories and literature in accordance with this list:

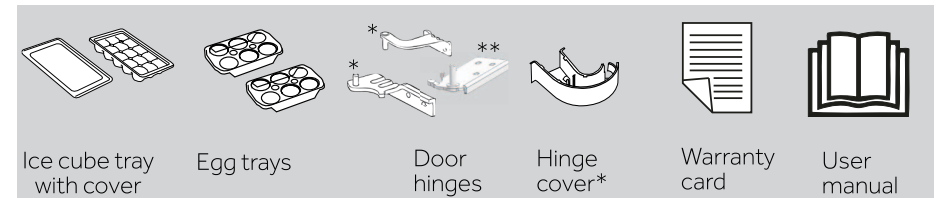

i Notice

Due to technical changes and different models, some of the illustrations in this manual may differ from your model.

- This appliance is intended to be used in household and similar applications such as
- staff kitchen areas in shops, offices and other working environments;
 - farm houses and by clients in hotels, motels and other residential type environments;
 - bed and breakfast type environments;
 - catering and similar non-retail applications.

Before switching on the appliance for the first time do...

- ▶ make sure there is no transport damage.
- ▶ make sure all packaging is removed and is kept out of children's reach.
- ▶ wait at least two hours before installing the appliance in order to ensure the refrigerant circuit is fully efficient.
- ▶ handle the appliance always with at least two persons because it is heavy.
- ▶ install the appliance in a well-ventilated place. Ensure a space of at least 5 cm above and 5 cm around the appliance. Install and level the appliance in an area suitable for its size and use.
- ▶ keep ventilation openings in the appliance or in the in-built structure clear of obstruction.
- ▶ make sure that the electrical information on the rating plate agrees with the power supply. If it does not, contact an electrician.
- ▶ consider that the appliance is operated by a 220~240 VAC/50 Hz power supply. Abnormal voltage fluctuation may cause the appliance to fail to start or not to operate correctly and damage the temperature control or compressor, originating abnormal noise too. To eliminate abnormal fluctuation it is suggested to use an automatic regulator.
- ▶ use a separate earthed socket for the power supply which is easy accessible. The appliance must be earthed. make sure the plug is easy accessible.
- ▶ ensure that the power cable is not trapped by the refrigerator. Do not step on the power cable.

WARNING!

Make sure not to damage the electric cable and the plug. If damaged it must only be re-placed by either the manufacturer or the authorised service agent.

Door Reversibility

Before connecting the appliance to the power supply you should check, whether the door swing must changed from right (as delivered) to left, if this is required by the installation location and the usability.

WARNING!

- ▶ The appliance is heavy. You need two persons to carry out the door reversibility.
- ▶ Before any operation, first unplug the appliance from the mains .
- ▶ Do not tilt the appliance more than 45 ° to prevent damage of the cooling system.

1. Provide necessary tool.
2. Unplug the appliance.
3. Remove the fixation of the cover
4. Remove the faceplate of the body
5. Remove the topplate of the upper door.
6. Remove the hinge cover.
7. Unplug the connection cable
8. Unscrew the upper hinge.
9. Lift the loose upper door carefully off the lower hinge.
10. Turn the upper door upside down and change the position of the hinge barrel on the lower side of the door.
11. Change the door stop from the current position to opposite side
12. Unscrew the lower hinge of the upper door.

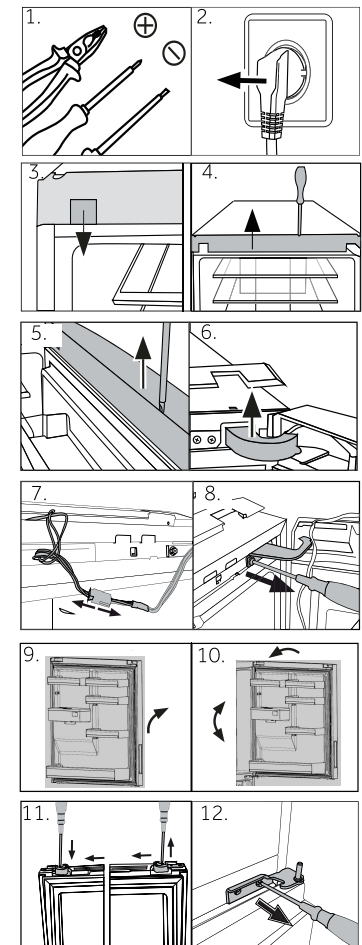

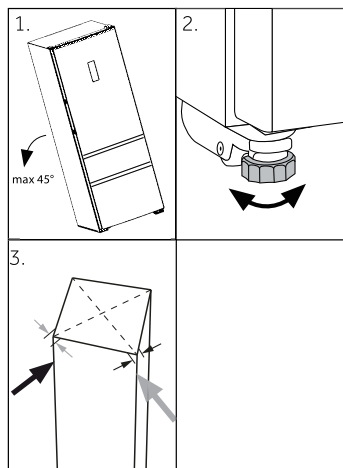

Aligning the appliance

The appliance should be placed on a flat and solid surface.

1. Tilt the appliance slightly backwards.
2. Set the feet to the desired level.

Make sure the distance to the wall on the hinge side is at least 100 mm for the door to open properly.

3. The stability can be checked by alternately bumping on the diagonals. The slightly swaying should be the same in both directions. Otherwise the frame can warp; possible leaking door seals are the result. A low tendency to the rear facilitates the closing of the door.

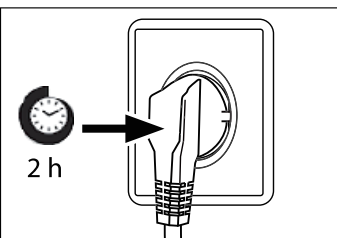

Waiting time

To the maintenance-free lubrication oil is located in the capsule of the compressor. This oil can get through the closed pipe system during slanting transport. Before connecting the appliance to the power supply you have to wait 2 hours so that the oil runs back into the capsule.

Electrical connection

Before each connection check if:

- ▶ power supply, socket and fusing are appropriate to the rating plate.
- ▶ the power socket is earthed and no multi-plug or extension.
- ▶ the power plug and socket are strictly according.

Connect the plug to a properly installed household socket.



WARNING!

To avoid risks a damaged power cord must be replaced by the customer service (see warranty card).

Before switching on the appliance for the first time do not...

- x install the appliance in direct sunlight or in the near of heat sources(e.g. stoves, heaters).
- x damage the refrigerant circuit. If it does become damaged, do not use the appliance.
- x use multi-plug adapters and extension cables.

During daily use do...

- ▶ make sure that this appliance is only used by children from the age of 8 as well as from persons with reduced physical, sensory or mental capabilities, or lack of experience and knowledge, if they are supervised or have been instructed how to use it in a safe way and understand the hazards involved.
- ▶ keep away children under 3 years of age from the appliance unless they are constantly supervised.
- ▶ make sure children are not playing with the appliance.
- ▶ make sure children are supervised if they carry out cleaning and maintenance.
- ▶ hold the plug, not the cable, when unplugging the appliance.
- ▶ replace a damaged supply cord only by the manufacturer, its service agent or similarly qualified persons in order to avoid a hazard.
- ▶ follow these instructions if coal gas or other inflammable gas is leaking in the vicinity of the appliance: turn off the valve of the leaking gas, open the doors and windows and do not unplug or plug in the power cable of the appliance or any other appliance.
- ▶ open and close the doors only with the handles. The gap between the doors and between the doors and the cabinet is very narrow. Do not extend your hands in these areas to avoid pinching your fingers. Open or close the refrigerator doors only when there are no children standing within the range of door movement.
- ▶ disconnect the appliance from the electrical supply before undertaking any routine maintenance. Allow at least 5 minutes before restarting the appliance, as frequent starting may damage the compressor.
- ▶ eliminate the dust on the back of the unit at least once in the year to avoid hazard by fire, as well as increased energy consumption.
- ▶ notice that the product is set for operation at a specific ambient range between 10 and 43°C. The appliance may not work properly

if it is left for a long period at a temperature above or below the indicated range.

- ▶ check the condition of food if a warming in the freezer has taken place.

During daily use do not...

- x set unnecessarily low temperature in the refrigerator compartment. Minus temperatures may occur at high settings. Attention: Bottles can burst.
- x store medicines which need a precision storage temperature or bacteria or chemical agents in the appliance.
- x store liquids in bottles or cans (besides high percentage spirits) especially carbonated beverages in the freezer, as these will burst during freezing.
- x place unstable articles (heavy objects, containers filled with water) on the top of the appliance, to avoid personal injury caused by falling or electric shock caused by contact with water.
- x pull on the door shelves. The door may be pulled slant, the bottle rack, may be pulled away, or the appliance may topple.
- x damage the refrigerant circuit. If it does become damaged, do not use the appliance.
- x step on the freezer storage compartment door or drawer.
- x touch the inside surface of the freezer storage compartment when in operation, especially with wet hands, as your hands may freeze onto the surface.
- x touch frozen goods with wet hands (wear gloves). Especially do not eat ice lollies immediately after removal from the freezer compartment. There is the risk to freeze or the formation of frost blisters. FIRST aid: keep immediately under running cold water. Do not pull away!
- x scrape off frost and ice with sharp objects. Do not use sprays, electric heaters like heater, hair dryer, steam cleaners or other sources of heat in order to avoid damage to the plastic parts.
- x use mechanical devices or other means to accelerate the defrosting process, other than those recommended by the manufacturer.
- x clean the appliance with hard brushes, wire brushes, detergent powder, petrol, amyl acetate, acetone and similar organic solutions, acid or alkaline solutions. Please clean with special refrigerator detergent to avoid damage.

Unpacking



WARNING!

- ▶ The appliance is heavy. Always handle with at least two persons.
- ▶ Keep all packaging materials out of children's reach and dispose them in an environmentally friendly manner.

- ▶ Take the appliance out of the packaging.
- ▶ Remove all packaging materials.

Environmental conditions

The room temperature should always be between 10° C and 43° C, since it can influence the temperature inside the appliance and its energy consumption. Do not install the appliance near other heat-emitting appliances (ovens, refrigerators) without isolation.

Do not place on the product on flooring covered with carpet, overly flexible, unstable or easily damaged by moisture.

Door reversibility

Before the appliance is permanently installed, check the correct position of the door hinge. If necessary see section the DOOR REVERSIBILITY.

Space requirement

Required space when door is opened:

Model	Appliance width in mm		Appliance depth in mm	
	W1	W2	D1	D2
HRF450BW2	1100	-	700	1323
HRF450BS2				
HRF450BHS2				
HRF450BHC2				

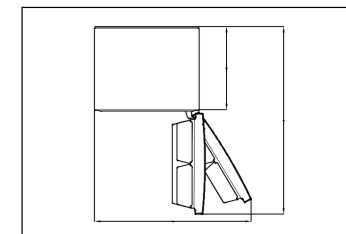

Ventilation cross-section

To achieve sufficient ventilation of the appliance for safety reasons, the information of the required ventilation cross sections must be observed.

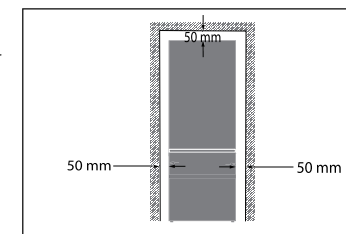

Problem	Possible Cause	Possible Solution
The appliance makes abnormal sounds.	<ul style="list-style-type: none"> The appliance is not located on level ground. The appliance touches some object around it. 	<ul style="list-style-type: none"> Adjust the feet to level the appliance. Remove objects around the appliance.
A slight sound is to be heard similar to that of flowing water.	<ul style="list-style-type: none"> - 	<ul style="list-style-type: none"> This is normal.
You will hear an alarm beep.	<ul style="list-style-type: none"> The fridge storage compartment door is open. The temperature in the freezer is too high. 	<ul style="list-style-type: none"> Close the door or silence the alarm manually. The alarm is normal when it is first started due to relatively higher temperature. You can silence the alarm manually (see section USE).
You will hear a faint hum.	<ul style="list-style-type: none"> The anti-condensation system is working 	<ul style="list-style-type: none"> This prevents condensation and is normal
The interior lighting or cooling system does not work.	<ul style="list-style-type: none"> Mains plug is not connected in the mains socket. The power supply is not intact. The LED-lamp is out of order. 	<ul style="list-style-type: none"> Connect the mains plug. Check the electrical supply to the room. Call the local electricity company! Please call the service for changing the lamp.

Power interruption

In the event of a power cut, food should remain safely cold for about 16 hours. Follow these tips during a prolonged power interruption, especially in summer:

- ▶ Open the door/drawer as few times as possible.
- ▶ Do not put additional food into the appliance during a power interruption.
- ▶ If prior notice of a power interruption is given and the interruption duration is longer than 16 hours, make some ice and put it in a container in the top of the refrigerator compartment.
- ▶ An inspection of the goods is required immediately after the interruption.
- ▶ As temperature in the refrigerator will rise during a power interruption or other failure, the storage period and edible quality of food will be reduced. Any food that defrosts should be either consumed, or cooked and refrozen (where suitable) soon afterwards in order to prevent health risks.

- x spray or flush the appliance during cleaning.
- x use water spray or steam to clean the appliance.
- x clean the cold glass shelves with hot water. Sudden temperature change may cause the glass to break.
- x use electrical devices inside the food storage compartments of the appliance, unless they are of the type recommended by the manufacturer.
- x try to repair the appliance by yourself. In case of repair please contact our customer service.
- x store explosive substances such as aerosol cans with a flammable propellant in this appliance.



WARNING!

Do not store or use inflammables, explosives or corrosive materials in the appliance or in the vicinity.

Refrigerant gas information



WARNING!

The appliance contains the flammable refrigerant ISOBUTANE (R600a). Make sure the refrigerant circuit is not damaged during transportation or installation. Leaking refrigerant may cause eye injuries or ignite. If a damage has occurred, keep away open fire sources, thoroughly ventilate the room, plug or unplug the power cords of the appliance or any other appliance. Inform the customer service.

In case of eyes get into contact with the refrigerant, rinse immediately it under running water and call immediately the eye specialist. This refrigerator may contain the flammable refrigerant isobutane - R600a.

It is hazardous for anyone other than an Authorised Service Person to service this appliance.

In Queensland - the authorized Service Person MUST hold a Gas Work Authorisation for hydrocarbon refrigerants, to carry out Servicing or repairs which involve the removal of covers.

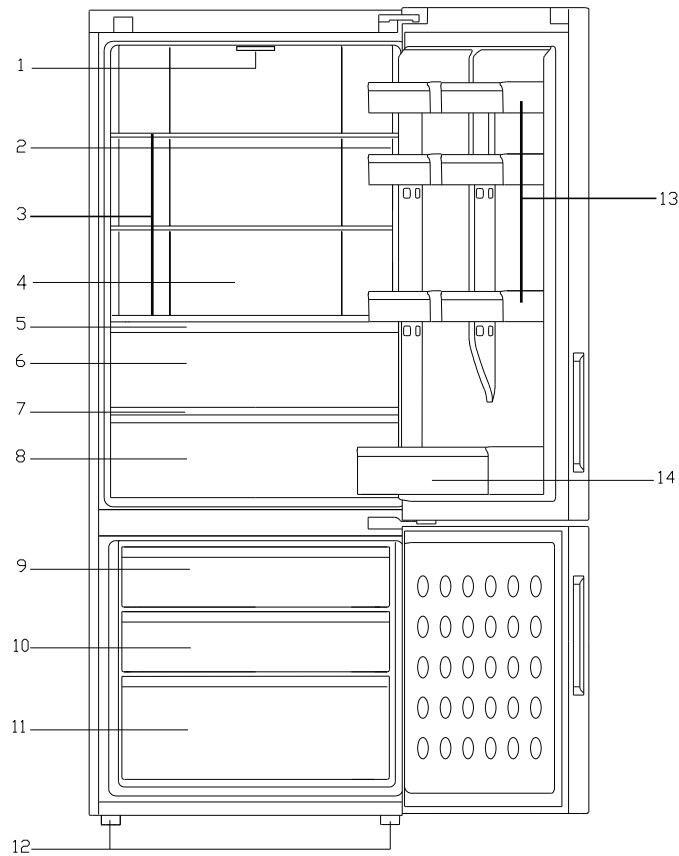

(HRF450BW2/HRF450BS2)

- | | |
|---------------------------|----------------------------------|
| 1 Refrigerator LED lamp | 8 My Zone bin |
| 2 Rating plate | 9 Upper freezer storage drawer |
| 3 Glass shelves | 10 Middle freezer storage drawer |
| 4 Air duct cover | 11 Lower freezer storage drawer |
| 5 Fresh Storage bin cover | 12 Adjustable feet |
| 6 Fresh Storage bin | 13 Adjustable door shelf |
| 7 My Zone glass cover | 14 Full-width door shelf |

Problem	Possible Cause	Possible Solution
It is not cold enough inside the appliance.	<ul style="list-style-type: none"> The temperature is set too high. Too warm goods has been stored. Too much food has been stored at one time. The goods are too close to each other. A door/drawer of the appliance is not tightly closed. The door/drawer has been opened too frequently or for too long. 	<ul style="list-style-type: none"> Reset the temperature. Always cool down goods before storing them. Always store small quantities of food. Leave a gap between several foods allowing air flowing. Close the door/drawer. Do not open the door/drawer too frequently.
It is too cold inside the appliance.	<ul style="list-style-type: none"> The temperature is set too low. The Super freeze/Super cool-function is activated or is running too long. 	<ul style="list-style-type: none"> Reset the temperature. Switch off the Super freeze/Super cool-function
Moisture formation on the inside of the refrigerator compartment.	<ul style="list-style-type: none"> The climate is too warm and too damp. A door/drawer of the appliance is not tightly closed. The door/drawer has been opened too frequently or for too long. Food containers or liquids are left open. 	<ul style="list-style-type: none"> Increase the temperature. Close the door/drawer. Do not open the door/drawer too frequently. Let hot foods cool to room temperature and cover foods and liquids.
Moisture accumulates on the refrigerators outside surface or between the doors/door and drawer.	<ul style="list-style-type: none"> The climate is too warm and too damp. The door/drawer is not closed tightly. The cold air in the appliance and the warm air outside it condensates. 	<ul style="list-style-type: none"> This is normal in damp climate and will change when the humidity decreases. Ensure that the door/drawer is tightly shut.
Strong ice and frost in the freezer compartment.	<ul style="list-style-type: none"> The goods were not adequately packaged. A door/drawer of the appliance is not tightly closed. The door/drawer has been opened too frequently or for too long. The door/drawer gasket is dirty, worn, cracked or mismatched. Something on the inside prevents the door/drawer to close properly. 	<ul style="list-style-type: none"> Always pack the goods well. Close the door/drawer. Do not open the door/drawer too frequently. Clean the door/drawer gasket or replace them by new ones. Reposition the shelves, door racks, or internal containers to allow the door/drawer to close.

Troubleshooting

Many occurring problems could be solved by yourself without specific expertise. In case of a problem please check all shown possibilities and follow below instructions before you contact an after sales service. See CUSTOMER SERVICE.

WARNING!

- ▶ Before maintenance, deactivate the appliance and disconnect the mains plug from the mains socket.
- ▶ Electrical equipment should be serviced only by qualified electrical experts, because improper repairs can cause considerable consequential damages.
- ▶ A damaged supply should only be replaced by the manufacturer, its service agent or similarly qualified persons in order to avoid a hazard.

Problem	Possible Cause	Possible Solution
The compressor does not work.	<ul style="list-style-type: none"> • Mains plug is not connected in the mains socket. • The appliance is in the defrosting cycle 	<ul style="list-style-type: none"> • Connect the mains plug. • This is normal for an automatic defrosting
The appliance runs frequently or runs for a too long period of time.	<ul style="list-style-type: none"> • The indoor or outdoor temperature is too high. • The appliance has been off power for a period of time. • A door/drawer of the appliance is not tightly closed. • The door/drawer has been opened too frequently or for too long. • The temperature setting for the freezer compartment is too low. • The door/drawer gasket is dirty, worn, cracked or mismatched. • The required air circulation is not guaranteed. 	<ul style="list-style-type: none"> • In this case, it is normal for the appliance to run longer. • Normally, it takes 8 to 12 hours for the appliance to cool down completely. • Close the door/drawer and ensure the appliance is located on a level ground and there is no food or container jarring the door. • Do not open the door/drawer too frequently. • Set the temperature higher until a satisfactory refrigerator temperature is obtained. It takes 24 hours for the refrigerator temperature to become stable. • Clean the door/drawer gasket or replace them by the customer service. • Ensure adequate ventilation.
The inside of the refrigerator is dirty and/or smells.	<ul style="list-style-type: none"> • The inside of the refrigerator needs cleaning. • Food of strong odour is stored in the refrigerator. 	<ul style="list-style-type: none"> • Clean the inside of the refrigerator. • Wrap the food thoroughly..

Product Description

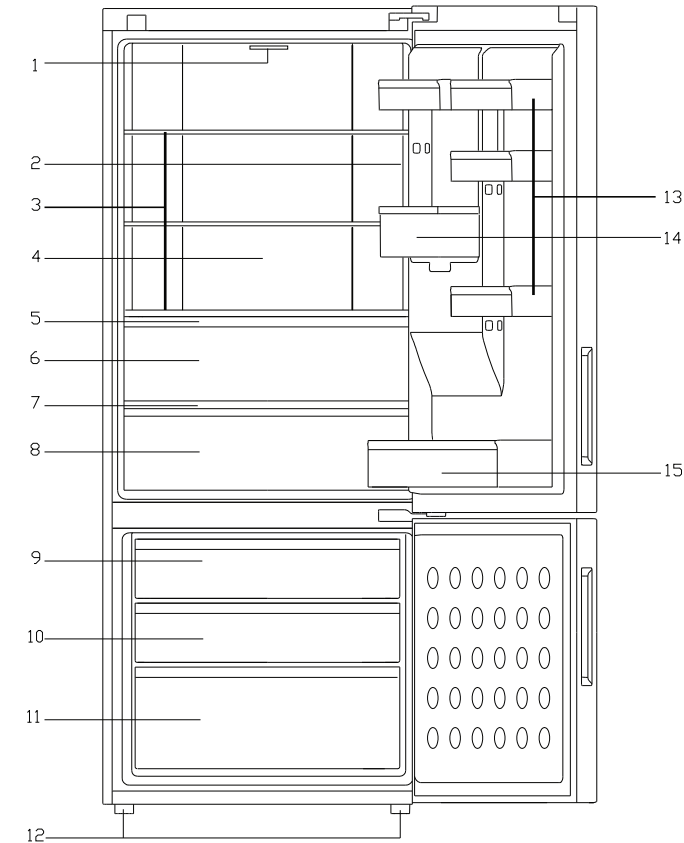

HRF450BHS/HRF450BHC

- | | |
|---------------------------|----------------------------------|
| 1 Refrigerator LED lamp | 8 My Zone Bin |
| 2 Rating plate | 9 Upper freezer storage drawer |
| 3 Glass shelves | 10 Middle freezer storage drawer |
| 4 Air duct cover | 11 Lower freezer storage drawer |
| 5 Fresh Storage Bin Cover | 12 Adjustable feet |
| 6 Fresh Storage Bin | 13 Adjustable door shelf |
| 7 My Zone glass cover | 14 Water tank |
| | 15 Full-width door shelf |

Before first use

- ▶ Remove all packaging materials, keep them out of children`s reach and dispose them in an environmentally friendly manner.
- ▶ Clean the inside and outside of the appliance with water and a mild detergent before putting any food in it.
- ▶ After the appliance has been levelled and cleaned, wait for at least 2 hours before connecting it to the power supply. See Section INSTALLATION.
- ▶ Precool the compartments at high settings before loading with food. The function Super Cool and Super Freeze help to cool down the compartments quickly.
- ▶ The refrigerator temperature and freezer temperature are automatically set to 5° C and -18° C respectively. These are the recommended settings. If desired, you can change these temperatures manually. Please see FUNCTIONS.

Defrosting

The defrosting of the refrigerator and the freezer compartment are done automatically; no manual operation is needed.

Replacing the LED-lamps



WARNING!

Do not replace the LED lamp yourself, it must only be replaced by either the manufacturer or the authorised service agent.

The lamp adopts LED as its light source, featuring low energy consumption and long service life. If there is any abnormality, please contact the customer service . See CUSTOMER SERVICE.

Parameters of the lamp:

Model	Fridge compartment		Freezer compartment	
	Voltage	Max Power	Voltage	Max Power
HRF450BW2	12V	2W	-	-
HRF450BS2				
HRF450BHS2				
HRF450BHC2				

Non-use for a longer period

If the appliance is not used for an extended period of time, and you will not use the Holiday-function for the refrigerator:

- ▶ Take out the food.
- ▶ Unplug the power cord.
- ▶ Clean the appliance as described above.
- ▶ Keep the door and freezer drawers/door open to prevent the creation of bad odours inside.



Notice

Turn the appliance off only if strictly necessary.

Moving the appliance

1. Remove all food and unplug the appliance.
2. Secure shelves and other moveable parts in the fridge and the freezer with adhesive tape.
3. Do not tilt the refrigerator more than 45° to avoid damaging the refrigerating system.



WARNING!

- ▶ Do not lift the appliance by its handles.
- ▶ Never place the appliance horizontally on the ground.

WARNING!

Disconnect the appliance from the power supply before cleaning.

Cleaning

Clean the appliance when only little or no food is stored. The appliance should be cleaned every four weeks for good maintenance and to prevent bad stored food odors.

WARNING!

- ▶ Do not clean the appliance with hard brushes, wire brushes, detergent powder, petrol, amyl acetate, acetone and similar organic solutions, acid or alkaline solutions. Please clean with special refrigerator detergent to avoid damage.
- ▶ Do not spray or flush the appliance during cleaning.
- ▶ Do not use water spray or steam to clean the appliance.
- ▶ Do not clean the cold glass shelves with hot water. Sudden temperature change may cause the glass to break.
- ▶ Do not touch the inside surface of the freezer storage compartment, especially with wet hands, as your hands may freeze onto the surface.
- ▶ In case of heating check the condition of frozen goods.

- ▶ Always keep the door gasket clean.
- ▶ Clean the inside and housing of the appliance with a sponge dampened in warm water and neutral detergent.
- ▶ Rinse and dry with soft cloth.
- ▶ Do not clean any of the parts of the appliance in a dishwasher.
- ▶ Allow at least 5 minutes before restarting the appliance as frequent starting may damage the compressor.

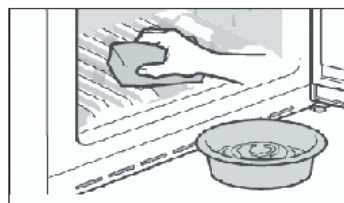

Cleaning the water tank (Only models with water dispenser)

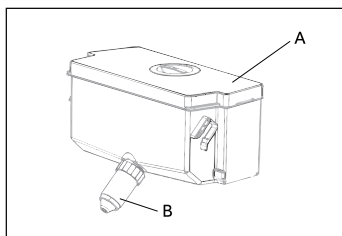

1. Take off the water tank out of the appliance.
2. Remove the cover (A).
3. Unscrew the dispenser cock (B)
4. Clean the tank and dispenser cock with warm water and liquid dishwashing detergent. Make sure all soap is rinsed off.
5. Mount the dispenser cock, close the cover and replace the tank inside the appliance.

Control panel

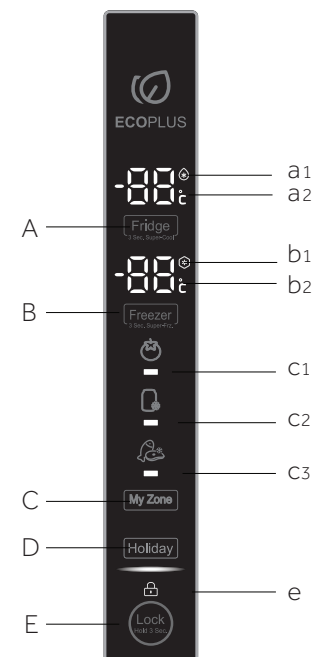

Buttons:

- A Fridge selector
- B Freezer selector
- C My Zone selector
- D Holiday selector
- E Panel lock selector

Indicators:

- a1 Super-cool Function
- a2 Temperature Fridge
- b1 Super-freeze Function
- b2 Temperature Freezer
- c1 Fruit & Vegetable Cooling
- c2 Beverage cooling
- c3 Meat&Seafood Cooling
- e Panel Lock Function

Sensor keys

The buttons on the control panel are sensor keys, which already respond when lightly touched with the finger.

Switch on /off the appliance

The appliance is in operation as soon as it is connected to the power supply.

When the appliance is powered on for the first time, indicator "c2" is shining on the display until the temperature reaches -5°C or after 1 hour working. The temperatures displayed in "a2", "b" and "c2" will show the actual temperatures in the compartment.



Notice

- ▶ The appliance is preset to the recommended temperature of 5°C (refrigerator) and -18°C (freezer). Under normal ambient condition you need not to set a temperature.
- ▶ When the appliance is switched on after disconnection from the main power supply, it may take up to 12 hours for the correct temperatures to be reached.

Empty the appliance before switching off. To switch off the appliance, pull the power cord out of the power socket.

Manual adjusting mode:

If you want to manually adjust the temperature of the appliance in order to store a particular food, you can set the temperature via a temperature adjusting button (refer to ADJUST THE TEMPERATURE).

Removable water tank (Only models with water dispenser)

The water tank can be removed and reinstalled for cleaning in the same way as the door racks.

Insert water tank (Only models with water dispenser)

Place the water tank in the position that the water outlet (B) fits into the opening of the door. Make sure that the water tank is locked.

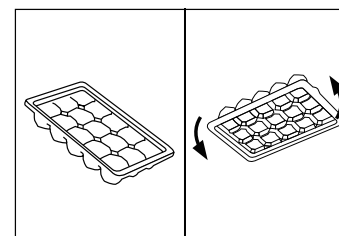
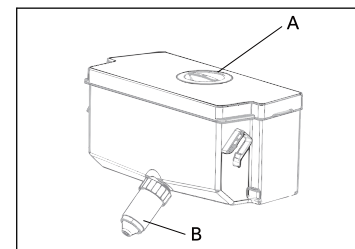

Ice cube tray

1. Fill the ice cube tray 3/4 full of water, close it with the cover and put it into the pre-freezing compartment.
2. Twist the ice cube tray slightly or hold it under flowing water to loosen the ice cubes.



Energy saving tips

- ▶ Make sure the appliance is properly ventilated (see INSTALLATION).
- ▶ Do not install the appliance in direct sunlight or in the near of heat sources (e.g. stoves, heaters).
- ▶ Avoid unnecessarily low temperature in the appliance. The energy consumption increases the lower the temperature in the appliance is set.
- ▶ Functions like SUPER COOL or SUPER FREEZE consume more energy.
- ▶ Allow warm food to cool down before placing it in the appliance.
- ▶ Open the appliance door as little and as briefly as possible.
- ▶ Do not overfill the appliance to avoid obstructing the air flow.
- ▶ Avoid air within the food packaging.
- ▶ Keep door seals clean so that the door always closes correctly.
- ▶ Defreeze frozen food in the fridge storage compartment.

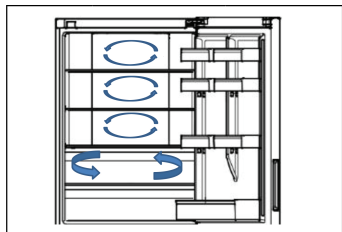

Multi-air-flow

The refrigerator is equipped with a multi-air-flow system, with which cool air flows are located on every shelf level. This helps to maintain a uniform temperature to ensure that your food is kept fresher for longer.

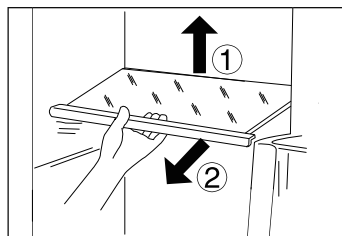

Adjustable shelves

The height of the shelves can be adjusted to fit your storage needs.

1. To relocate a shelf, remove it first by uplifting its hind edge (1) and pulling it out (2).
2. To reinstall it, put it on the lugs on both sides and push it to the most rearward position until the rear of the shelf is fixed inside the slots in the sides

i Notice:

Ensure that all ends of a shelf are level.

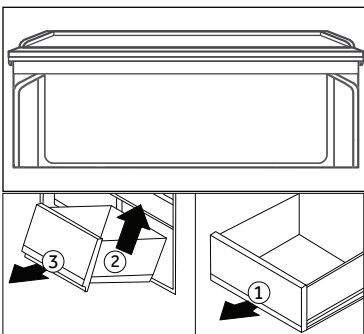

My Zone bin and Fresh Storage bin

For use and setting of the My Zone bin please check section USE.

To remove the bin:

- Pull out (1) to the maximum extent.
Lift (2) to separate the bin from the rail and remove (3).

It can be mounted in reverse order.

Use same process for the Fresh Storage bin.

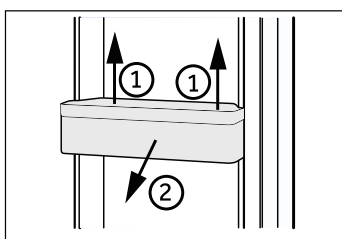

Removable door racks

The door racks can be removed for cleaning:

Place hands on each side of the rack, lift it upwards (1) and pull it out (2).

In order to insert the door rack, the above steps are carried out in reverse order.

Lock/unlock panel

- ▶ Touch button "E" for 3 seconds to block all panel elements against activation. The related indicator "e" is now displayed.
- ▶ For unlocking press again the button.



i Notice

The control panel is automatically blocked against activation if 30 seconds no button is pressed. For any settings the control panel must be unlocked.

When the refrigerator door is opened for more than 3 minutes, the door opening alarm will sound. The alarm can be silenced by either closing the door or touching the control panel. If the door is left open for more than 7 minutes, the light inside the refrigerator and control panel illumination will auto-matically switch off.

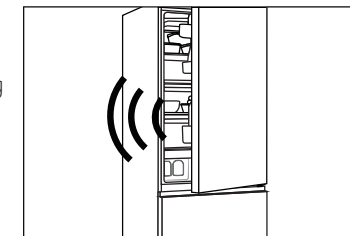

Adjust the temperature

The indoor temperatures are influenced by the following factors:

- ▶ Ambient temperature
- ▶ Frequency of door opening
- ▶ Amount of stored foods
- ▶ Installation of the appliance

Adjust the temperature for fridge

1. Unlock the panel if it is locked.
2. Press button "A" (Fridge) for select the fridge compartment. Indicator "a2" is flashing.
3. Press button "A" to set the refrigerator temperature.

The temperature increases in sequences of 1°C from a minimum of 1°C to a maximum of 9°C, switching to 1°C again when pressing further. The optimum temperature in the refrigerator is 3°C. Colder temperatures mean unnecessary energy consumption.

4. Press any key except "A" to confirm, or the setting confirms automatically after 5 seconds. Indicator "a2" stops flashing

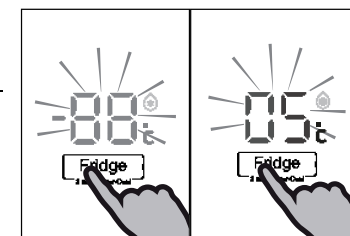

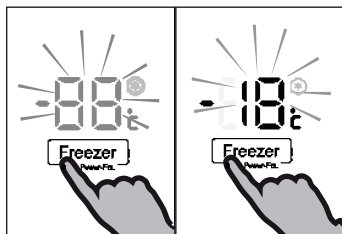

Adjust the temperature for freezer

1. Unlock the panel if it is locked.
2. Press button "B" (Freezer) for select the freezer compartment. Indicator "b2" is flashing.
3. Press button "B" (Freezer) to set the freezer temperature.
The temperature increases in sequences of 1°C from a minimum of -14°C to a maximum of -24°C, switching to -14°C again when pressing further.
The optimum temperature in the freezer is -18°C. Colder temperatures mean unnecessary energy consumption.
4. Press any key except "B" (Freezer) to confirm, or the setting confirms automatically after 5 seconds. Indicator "b2" stops flashing.

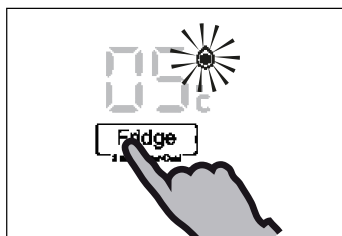

Super cool function

Switch on the Super cool function if larger quantity of food should be stored (for example after the purchase). The Super cool function accelerates the cooling of fresh food and protects the goods already stored from undesirable warming. The factory setting temperature is + 1°C.

1. Unlock the panel if it is locked.
2. Press button "A" (Fridge) for 3 seconds. Indicator "a1" illuminates and the function is activated.
3. The same operation can exit super cool function.



Notice

This function will be automatically disabled after 3 hours.



Super freeze function

Fresh food should be frozen as quickly as possible to the core. This preserved the best nutritional value, appearance and taste. The Super freeze function accelerates the freezing of fresh food and protects the goods already stored from undesirable warming. If you need to freeze a large amount of food once, it is recommended to set the Super -freeze function on ahead for 24h before the usage of frozen room.

1. Unlock the panel if it is locked.
2. Press button "B" (Freeze) for 3 seconds Indicator "b1" illuminates and the function is activated.
3. The same operation can exit super freeze function.

Storage into the freezer compartment

- ▶ Keep the freezer temperature at - 18°C.
- ▶ 24 hours before freezing switch on the Super-freeze function; -for small quantities of food 4-6 hours are sufficient.
- ▶ Hot food must be cooled to room temperature before storing in the freezer compartment.
- ▶ Food cut into small portions will freeze faster and be easier to defrost and cook. The recommended weight for each portion is less than 2.5 kg
- ▶ It is better to pack food before putting it into the freezer. The outside of the packaging must be dry to avoid bags sticking together. Packaging materials should be odour-free, airtight, non-poisonous and nontoxic.
- ▶ In order to avoid expiration of storage periods, please note the freezing date, time limit and name of the food on the packaging according to the storage periods of different foods.
- ▶ **WARNING!** Acid, alkali and salt etc. could erode the internal surface of the freezer. Do not place the food having these substances (e.g. sea fish) directly on the internal surface. Salt water in the freezer should be cleaned up immediately.
- ▶ Do not exceed the food storage times recommended by the manufacturers. Only take the required amount of food out of the freezer.
- ▶ Consume defrosted food quickly. Defrosted food cannot be re-frozen unless it is first cooked, otherwise it may be less edible.
- ▶ Do not load excessive quantities of fresh food in the freezer compartment. Refer to the freezing capacity of the freezer – See TECHNICAL DATA or data at the type plate.
- ▶ Food can be stored in the freezer at a temperature of at least -18°C for 2 to 12 months, depending on its properties (e.g., meat: 3-12 months, vegetables: 6-12 months)
- ▶ When freezing fresh food, avoid bringing it in contact with already frozen food. Risk of thawing!
- ▶ Defreeze frozen food in the fridge. This way, you can use the frozen food to decrease the temperature in the compartment and save energy.

When storing commercially frozen foods, please follow these guidelines:

- ▶ Always follow manufacturers' guidelines for the length of time you should store food for. Do not exceed these guidelines!
- ▶ Try to keep the length of time between purchase and storage as short as possible to preserve food quality.
- ▶ Buy frozen foods, which have been stored at a temperature of -18°C or below.
- ▶ Avoid buying food which has ice or frost on the packaging – This indicates that the products might have been partially defrosted and refrozen at some point – temperature rises affect the quality of food.

Tips on storing fresh food

Storing into the refrigerator compartment

- ▶ Keep your fridge temperature below 5°C.
- ▶ Hot food must be cooled to room temperature before storing in the appliance.
- ▶ Foods stored in the refrigerator should be washed and dried before storing
- ▶ Food to be stored should be properly sealed to avoid odour or taste alterations.
- ▶ Do not store excessive quantities of food. Leave spaces between foods to allow cold air flowing around them, for a better and more homogeneous cooling.
- ▶ Foods eaten daily should be stored at the front of the shelf.
- ▶ Leave a gap between foods and the inner walls, allowing air flowing. In special way don't store foods against the rear wall: foods could freeze against rear wall. Avoid direct contact of food (especially oily or acidic food) with the inner liner, as oil/acid can erode the inner liner. Clean away oily/acid dirt whenever it is found.
- ▶ Defreeze frozen food in the fridge storage compartment. This way, you can use the frozen food to decrease the temperature in the compartment and save energy.
- ▶ The ageing process of fruit and vegetables such as courgettes, melons, papaya, banana, pineapple, etc. can be accelerated in the refrigerator. Therefore, it is not advisable to store them in the refrigerator. However, the ripening of strongly green fruits can be promoted for a certain period. Onions, garlic, ginger and other root vegetables should also be stored at room temperature.
- ▶ Unpleasant odours inside the fridge are a sign that something has spilled and cleaning is required. See CARE AND CLEANING.
- ▶ Different foods should be placed in different areas according to their properties:

Food	Location
Butter, cheese	Upper door rack
Eggs	Door rack
Fruit, vegetables, salad	Fresh storage bin(Humidity function)
Meat, sausage, cheese, milk	Lower area (lowest shelf / coverage above the fruit-and vegetable box)
Dairy products, canned food, cans	Upper area or door rack
Drinks, bottles, tubes	Door rack or My Zone 0 °C
Fresh meat, fresh fish, sausages, cooked foods	My Zone(Meat-Seafood function)



Notice

The Super-freeze function will automatically switch off after **50** hours. The appliance is then operated at the previously set temperature.

My Zone Storage

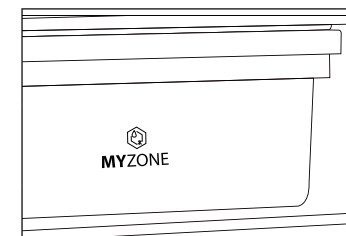
The fridge compartment is equipped with a My Zone drawer. In accordance with the food's storage demands, the most suitable function can be selected to get the optimal nutritional value of the foods. The following functions are available.



-  Fruit and Vegetable function (2-4 °C) is suitable to store fruit and vegetable.
-  Beverage Cooling function(0 °C) is suitable to cool beverages like beer, soft-drinks, yogurts, etc.
-  Seafood and meat function(-3 °C) is suitable to store fresh seafood and meat.

Notice

Due to the different water content within different types of meat or seafood, on occasions it may occur that some food will experience freezing to a degree when stored at temperature of 0 °C or below. Freshly cut meat should be stored in the My Zone drawer. Please do not store fruit and vegetables in the Seafood and Meat function. Due to the high water content of fruits and vegetables, it is likely they will experience some freezing and be damaged. It is easy to freeze fruit and vegetables.

Select the function for My Zone drawer

1. Unlock the panel if it is locked.
2. Press button "C" to select the My Zone function.
 - Fruit and Vegetable "c1" light.
 - Beverage Cooling "c2" light.
 - Seafood and meat "c3" light.
3. Press and key except "C" (My Zone) to confirm, or the setting confirms automatically after 5 seconds. Indicator "C" stops flashing.

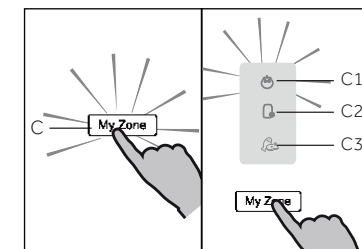

Notice

My zone storage temperature setting number cannot be higher than the fridge temperature setting number.

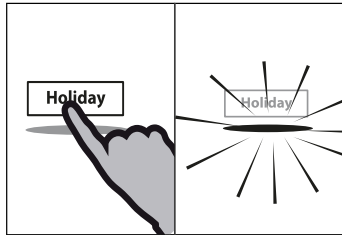

Holiday function

This function sets the refrigerator temperature permanently to 17°C.

This allows to keep the door of the empty refrigerator closed without causing an odour or mold - during a long absence (e.g. during holiday). The freezer compartment is free for your setting.

- ▶ Unlock the panel if it is locked.
- ▶ Press button F (Holiday).
- ▶ Indicator illuminates and the function is activated.
- ▶ The function can be deactivated by pressing button F (Holiday) again or by setting the refrigerator temperature or by performing any other setting

WARNING!

During the holiday function no goods must be stored in the refrigerator compartment. The temperature of + 17 °C is too high for storing food.

Water dispenser (Only models with water dispenser)

With the water dispenser cool drinking water can be tapped. The water tank should be cleaned before first use (see CARE AND CLEANING).

Filling the water tank

WARNING!

Use drinking water only.

1. Ensure that the water tank is properly inserted (see EQUIPMENT)
2. Rotate and lift the round lid (A) and fill the water tank up with fresh drinking water.
3. Fill water only up to the mark (2.5l); as it could overflow when the door opens and closes.
4. Close the round lid until it clicks into place.

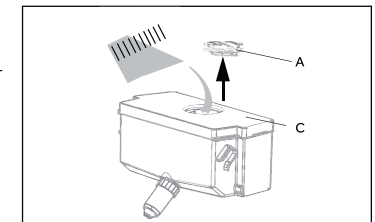

Notice

- ▶ Before refilling dispose residual water and clean the water tank.
- ▶ When you don't need water for a long time, please empty the water tank and insert the cleaned tank.
- ▶ The cover (C) on the water tank is additionally used to save energy. If you do not want to get water from the water dispenser for a long period, please still install the cover because of better insulating and saving energy.

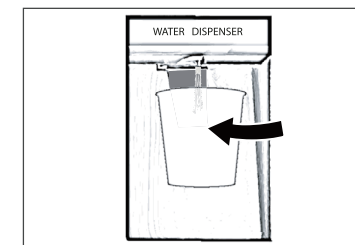

Getting water from the dispenser

1. Place a glass underneath the water outlet.
2. Push it gently against the water dispenser lever with your glass.

Make sure the glass is in line with the dispenser to prevent the water from splashing out.