

Haier

User Manual Dishwasher

HDWI3F0SI/HDWI3F0WI
HDWI3F0BI/HDWI3F0PSI

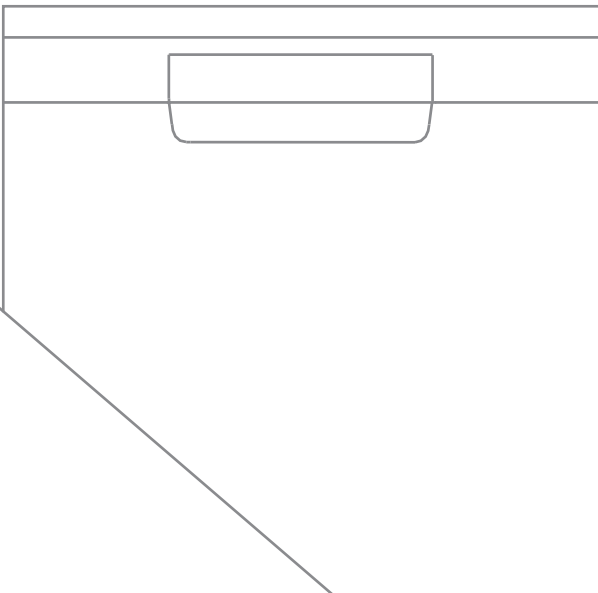

NZ AU

Please read these instructions carefully before using this appliance.

These instructions contain important information which will help you get the best experience of the appliance. Reading the manual carefully can help to ensure your safety and proper installation and better maintenance in the future.

Keep this manual in a convenient place so you can always refer to it for the safety and proper use.

If you sell the appliance, or give it away, or leave it behind when moving your house, make sure you already passed on the manual to it's new owner, so that they can become familiar with the appliance and safety warnings.

Legend



General information and tips



Warning—Important Safety information



Environmental information

Disposal



Help protect the environment and human health. Put the packaging in applicable containers to recycle it. Help to recycle waste of electrical and electronic appliances. Don't dispose appliances marked with this symbol with the household waste. Return the product to your local recycling facilities or contact with your municipal offices.



WARNING!

Risk of injury or suffocation!

Disconnect the appliance from the main supply. Cut off the main cable and dispose of it. When you remove the door catch, be sure to prevent children and pets to get closed to the appliance.

Safety	3
Installation	5
Technical Data	9
Product Description	10
Control Panel	11
Program	13
Before first use	14
Daily Use	19
Care and Cleaning	25
Troubleshooting	28
Customer service	31
Standards test information	31
Manufacturer's Warranty	32

Intended Use

The appliance is designed for domestic use, including the below environments inside the house, staff kitchen areas, farm houses, hotels, motels or other residential environments. It is not intended for commercial or industrial use. Do not use it for purposes other than that for which it was designed.

Changes or modifications to the device are not allowed. Unintended use may cause hazards and loss of warranty claims.

Before Switching on the Appliance for the First Time Do...

- ▶ to make sure all packaging is removed and is kept out of children's reach.
- ▶ to make sure that the electrical information on the rating plate agrees with the power supply, if not, contact with electricians.
- ▶ use a separate earthed socket for the power supply. The appliance must be earthed.
- ▶ to make sure the plug is accessible.
- ▶ to make sure only the delivered electric cable and hose set are used.
- ▶ hold the plug and not the electric cable when unplugging the power supply.
- ▶ to make sure not to damage the electric cable and the plug. If damaged, have it replaced by an electrician.
- ▶ to make sure the hose joints and connections are firmed and there is no leakage.

Do not...

- ✗ install or use the appliance where the temperature is below 5 °C. Use multi-plug adapters and extension cables.
- ✗ let people (children included), with reduced physical sensory, and mental functions or lack of experience and knowledge use the appliance also not supervised by a person, who is responsible for their safety.
- ✗ put wet flammable products in, near, or on the appliance.

During Daily Use

Do...

- ▶ supervise children and stop them to play with the appliance.
- ▶ put sharp pointed objects (e.g. knives) in a way that there is no danger of injury.

Do not...

- × open the door while a programme is operating. The appliance can release hot steam.
- × keep the appliance door open without supervision to prevent tripping and falling.
- × let children or pets come close to the appliance when the door is open.
- × sit or place heavy items on the open door.
- × remove the dishes from the appliance until the programme is completed. Otherwise, there can still be detergent on the dishes.
- × drink the water in the appliance. The water may be contaminated with detergent residues.
- × cover any ventilation openings in the base by a carpet or similar object.
- × use water spray or steam to clean the appliance.
- × let the children make the cleaning and user maintenance without supervision.

WARNING:

Some dishwasher detergents are strongly alkaline. They can be extremely dangerous if swallowed. Avoid touch with the skin and eyes and keep children away from the dishwasher when the door is open. Check that the detergent receptacle is empty after completion of the wash cycle.

- The door is not left in the open position since this could present a tripping hazard.
- Warning: Knives and other utensils with sharp points must be loaded in the basket with their points down or placed in a horizontal position.
- Only use hose-set provided by manufacture, old hose-set cannot be reused.



WARNING!

Any installation need to carried out only by a qualified technician refer to section "safety".

Free Standing Installation

Install the appliance on horizontal ground.

Adjust accurately all feet to get a firm, horizontal position.



Only with a correct level the appliance door closes and seals correctly.

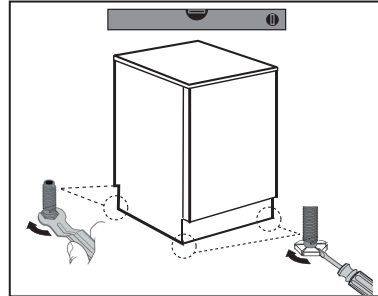

Installation under worktop

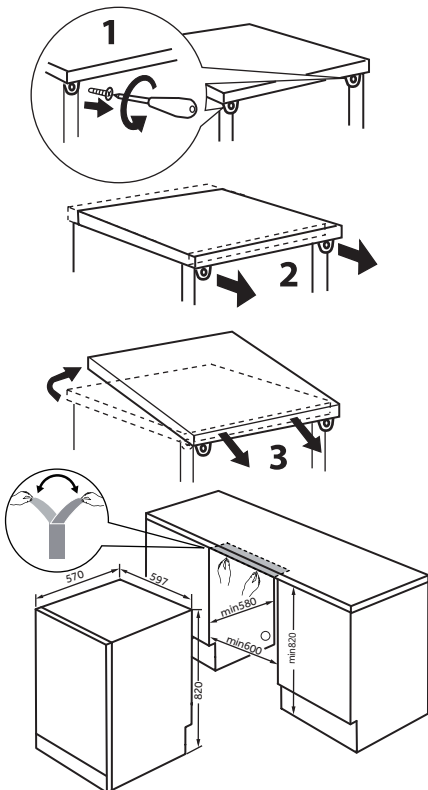

1. Optional: Remove the worktop of the appliance.
2. Adjust accurately all feet to get a firm level position.
3. Install the appliance carefully into the recess.



WARNING!

If used as free standing appliance again, the worktop must be remounted.

4. The dimensions of the recess should at least match with the dimensions in the figure
5. After installation, the minimum gap between the side panel and the cupboard is 1mm, and the minimum gap between the rear and the cupboard is 10mm. The top gap is controlled by adjusting the feet.
6. Put the appliance adjacent to the slot. Make sure that all connections (water, drain water, power) are neatly positioned and connected.

Fresh Water Connection

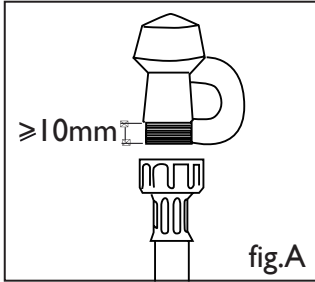

IMPORTANT!

- ▶ The appliance should be connected to the water main using the new water inlet hose supplied. Old hoses shouldn't be used.
- ▶ Don't shorten the inlet hose.

1. Take note of water connection requirements.
 - ▶ The dishwasher has a single valve water connection.
 - ▶ We recommend a cold water connection for best performance and energy efficiency.
 - ▶ The incoming water temperature shouldn't exceed 25°C .
2. Take note of the permitted water pressure extremes.
 - ▶ Lowest: $0.3\text{ bar} = 3\text{ N/cm}^2 = 0.03\text{MPa}$
 - ▶ Where pressure is below 1 bar, contact with qualified plumbers.
 - ▶ Highest: $10\text{ bar} = 100\text{ N/cm}^2 = 1\text{MPa}$
 - ▶ Where pressure is above 10 bar, a pressure reduction valve must be installed. Contact with qualified plumbers.
3. Connect the water inlet hose to an accessible water tap with a $3/4''$ BSP connector (see fig.A). Ensure that there is no kink in the inlet hose, because this will restrict the flow of water. A 90° bend requires a minimum height of 200 mm for a kink-free curve.
 - ▶ Ensure incoming water is clear. If the water pipes have not been used for a long period, let the water run in the pipes, to make sure it is clear with no impurities. If not, it will result in the water inlet hose getting blocked and damaging the appliance.
 - ▶ If required, use a filter insert to filter out deposits from the piping. The filter insert is available from your authorised service centre or customer care.
4. Tighten the hose coupling a further half turn after seal contact.
5. Confirm that the connections don't leak.

Drain Water Connection

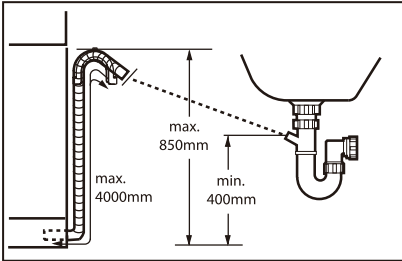

Fix the water drain hose properly to the piping. The hose has to reach at one point a height between 400 and 850 mm above the appliance bottom line.

An extension hose for the water drain hose can't exceed a total length of 4m and must have the same diameter as the water drain hose.

Drain hose to waste water connection

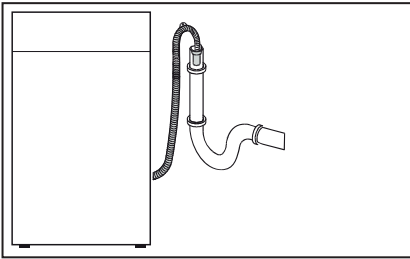

- ▶ The internal diameter of the stand pipe with vent-hole must be minimum 40 mm.
- ▶ Put the drain hose for approx. 80 mm in the wastewater pipe.
- ▶ The top of the drainage pipe is fixed with a tie, and the height of the tie must be higher than the height of the drainage pipe mouth

Drain hose to sink connection

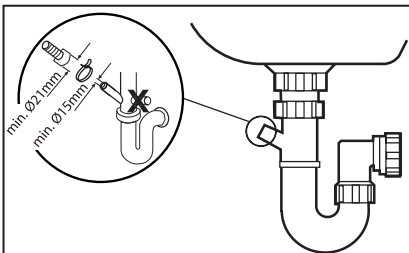

- ▶ When connecting the drain hose to a sink trap with a drain hose spigot, make sure that the drain hose is supported to the height of the bench.
- ▶ Ensure the drain spigot has a minimum hole diameter of 15 mm and it has been drilled out.

Power connection

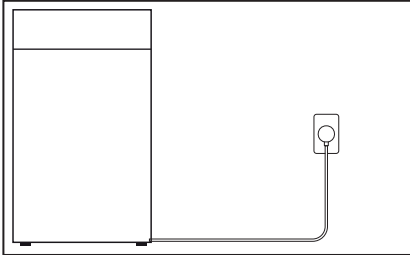

As shown in the data, the power supply is plugged into an externally accessible place through the service hole for easy plugging.



CAUTION!

Always ensure that all connections (power supply, drain and fresh water hose) are firm, dry and not leaked.

Take care these parts are never to be crushed, kinked, or twisted. If the supply cord is damaged, it must be replaced by the service agent (see warranty card) in order to avoid hazards.

Service hole

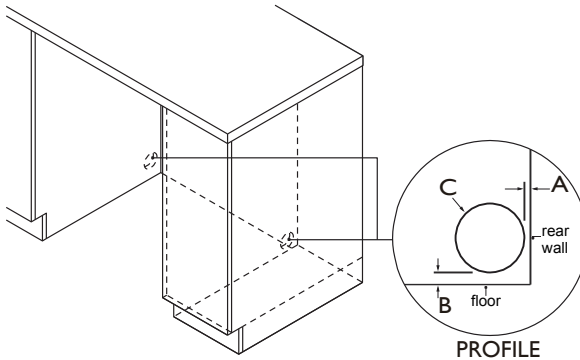

Service hole dimensions

MM

A	Maximum distance between rear of cavity and service hole*	15
B	Maximum distance between floor and service hole**	50
C	Minimum diameter of service hole	70

* based on a cabinetry depth of 580mm.

** depending on adjustment of levelling feet.

Check the electrical data on the rating label (located on the left-hand side of the dishwasher's stainless steel inner door). If the data on the rating label is different from those specified below, consider those on the rating label as correct.

Suppliers name or trade mark	Haier
Supplier's model identifier	HDWI3F0SI/HDWI3F0WI HDWI3F0BI/HDWI3F0PSI
Rated capacity in standard place settings	13
Mainswater pressure	0.03 - 1Mpa
Power voltage	220-240 V (50Hz)
Maximum current intensity	10 A
Total absorbed power	1720-2050 W

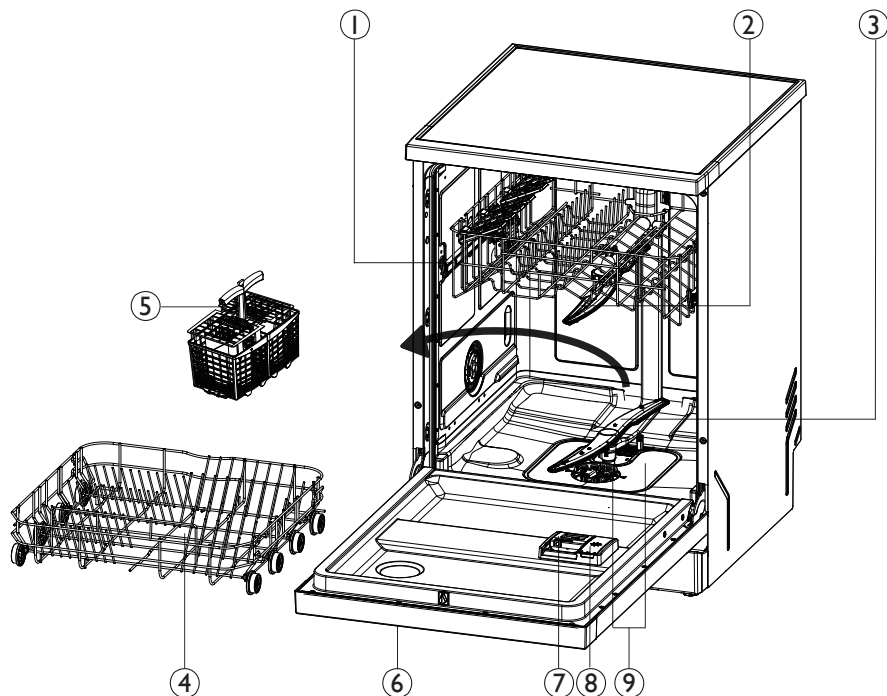

1. Upper basket
2. Upper spray arm
3. Lower spray arm
4. Lower basket
5. Cutlery basket
6. control panel
7. Detergent dispenser
8. Rinse aid dispenser
9. Filters

Accessories

Check the accessories and literature in accordance with this list:



water inlet hose



User manual

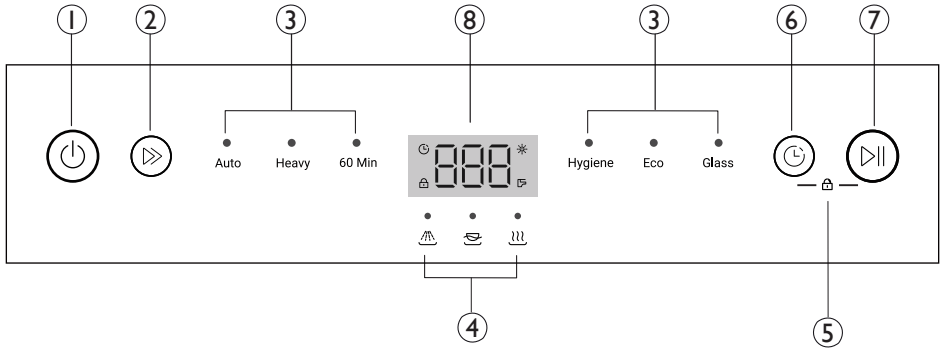

1. ON / OFF button
2. PROGRAMME SELECT button
3. Programme indicators
4. Status indication
5. Child Lock
6. START DELAY button
7. START / PAUSE button
8. Time & Info Display/Indicator icon

Time & Info display

During any selection the display shows by flashing related information like

- ▶ Programme cycle time
- ▶ Programme start delay time
- ▶ Error codes and service information

After start of an operation it displays without flashing

- ▶ Remaining time in hours of a delayed programme starts, e.g. 24h
- ▶ Remaining programme cycle time in minutes, e.g. 130

While running it may be limited to local conditions and daily working load.

Indicator Icon



Rinse aid

If the indicator light on: Rinse aid is empty!
After adding Rinse Aid, the indicator lights off.



Water tap

If the indicator light on, The appliance does not fill with water. Check section: "TROUBLE SHOOTING"



Delay

If the indicator light on, a delay start has been activated.



Child Lock

If the indicator light on: Child Lock mode has been activated.

Status Indicators



Wash

If the indicator is flashing: the Dishwasher is washing.



Rinse

If the indicator is flashing: the Dishwasher is rinsing.



Dry

If the indicator is flashing: the Dishwasher is drying.

Optional function



Child Lock

To activate or cancel Child Lock, press and hold until the Child Lock indicator comes on or turn off.



Delay start

You can delay the start of a programme in 1 hour
Up to 24 hours. Check the catalog under "Daily use" part.

Programme	Type of food residue	Type of load
Auto	Light to heavy soil: casserole, sauce, potato, pasta, rice, roasted or fried food	Non-delicate: dinnerware, cutlery, pots and pans
Heavy	Heavy soil: casserole, sauce, potato, pasta, rice, roasted or fried food	Non-delicate: dinnerware, cutlery, pots and pans
60 Min	Mixed soil: coffee, cake, milk, cold drink, salad, sausage, pasta, roasted or fried food	Non-delicate: dinnerware, cutlery, pots and pans
Hygiene	Hygiene soil: casserole, sauce, potato, pasta, rice, roasted or fried food	Non-delicate: dinnerware cutlery, pots and pans
Eco	Normal soil: soup, egg, sauce, potato, pasta, rice, roasted or fried food	Non-delicate: dinnerware, cutlery, glassware
Glass	Light soil: coffee, cake, milk, cold drink, salad, sausage	Delicate: glassware, dinnerware, cutlery

1). The Auto and Hygiene programs can automatically detect the dirty degree and it will adjust the temperature, water volume, and programs automatically.

First Step

Remove all packaging materials, keep them out of children's reach and dispose them in an environmentally manner. There could be water residue inside the appliance due to quality checks in the factory.



Perform in the following steps:

1. Install the appliance.
 - ▶ Refer to section INSTALLATION.
2. Only for use of multitabs: adjust the rinse aid setting.
 - ▶ Refer to section DIFFERENT SETTINGS FOR RINSE AID.
3. Fill the rinse aid dispenser.
 - ▶ Refer to section HOW TO FILL THE RINSE AID DISPENSER.
4. Open the water tap.
5. Start any wash programme (apart from Rinse programme) with detergent but no load to remove possible manufacturing residues.

Activate / De-Activate the Buzzer

An acoustic signal informs about the end of a programme. This signal can be switched off.

Refer to section HOW TO ADJUST SETTINGS and select the setting:

- ▶ If the display shows  the signal is switched off.
- ▶ If the display shows  the signal is switched on.

Different Settings for Rinse Aid



Rinse aid is added during the last rinsing phase to dry the dishes without streaks and stains.

Detergent (e.g. powder, tablets, ...)

- ▶ require separate rinse aid:
Factory default setting: . No settings are necessary.
The rinse aid is added from the rinse aid dispenser only.

Detergent with multifunction (e.g. Multitabs)

- ▶ combine detergent and rinse aid:

The rinse aid setting should be adjust to . Please use the setting instructions in section HOW TO ADJUST SETTINGS and select the -setting.

The rinse aid is added from the rinse aid dispenser in addition to the multitabs rinse aid.

Setting - cuts off the rinse aid dosage and the rinse aid indication. The higher the value for the higher the dosage.

Usually the recommended setting performs well. In case of streaks, stains, shimmer etc., refer to section TROUBLESHOOTING.

How to fill the Rinse Aid Dispenser



CAUTION!

Only use rinse aid for dishwashers.

Other products will result in damage to the appliance.

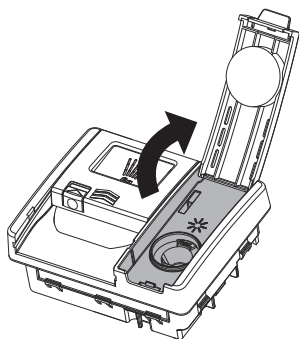

Lift the cover open and pour rinse aid into the opening.

Don't fill the rinse aid over the MAX line.

Take care and don't spill any onto the door or detergent bucket.

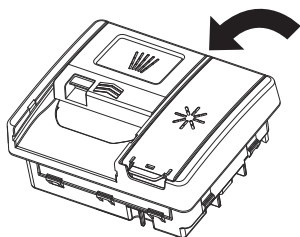

Close the cover, ensure it clicks shut.

Powder detergent quantity recommendations

Use the table below to determine the optimal powder detergent quantity for each wash programme.

If the water quality is poor in your area, more detergent may be required.

Refer to 'Water Hardness' for more details.

WASH PROGRAM	PRE WASH COMPARTMENT	MAIN WASH COMPARTMENT
Auto	None	1/2 - 2/3
Heavy	Full	2/3
60Min	Full	1/2
Hygiene	None	1/2
Eco	Full	2/3
Glass	Full	2/3

How to Adjust Settings

Adjust the Rinse Aid level

1. The appliance is switched on.
2. Press and hold \gg about 3 seconds until:
 - ▶ The display shows the current Rinse Aid setting (the default is $\square\square$).
3. Press \odot to change the Rinse Aid setting in steps between $\square-$ (minimum dispense, no rinse aid is set) and $\square\square$ (maximum dispense, represents putting in 6ml rinse aid).
4. Press $\triangleright||$ to save the option.
5. To exit the Rinse Aid menu, press and hold \odot for 1 second.

Activate / De-Activate the Buzzer



1. The appliance is switched on.
2. Press and hold \gg for about 3 seconds until :
 - ▶ The display shows the current Rinse Aid setting.
3. Press \gg to scroll to the buzzer menu.
4. The display will show $\square|$ (buzzer on).
5. Press \odot to toggle between $\square\square$ (buzzer off) or $\square|$ (buzzer on),
6. Press $\triangleright||$ to save the option.
7. To exit, press and hold \odot 1 second.

Child Lock

This feature disables all the buttons on the dishwasher. If any other buttons are pressed while Child Lock is activated, The display will show CLO, the Child Lock indicator will flash for a few seconds.

1. To activate Child Lock, press \odot and $\triangleright||$ for 3 seconds.
2. The display will remain on (if no programme has been started it will continue to flash while the control panel is locked).
3. To cancel Child Lock, press \odot and $\triangleright||$ for 3 seconds.

Dishwasher operation

1. Load the baskets.
2. Press the ON/OFF button  to activate the appliance.
 - ▶ If the rinse aid indicator is on, fill the rinse aid dispenser and reset the rinse aid indicator, refer to section HOW TO RESET THE RINSE AID INDICATOR.
3. Add the detergent; refer to section DETERGENT.
4. Close the door.
5. Set the program according to the type of load and how dirty the dishes, cups and cutlery are.
6. Maybe select a start delay time.
7. Press the START / PAUSE button  to start the program.
8. After the program ends the appliance changes to auto-off. Unload the baskets.

How to Reset Rinse Aid Indicator

The rinse aid indicator is on:

1. Always completely fill the rinse aid before starting the next wash cycle.
2. After each filling, press and hold the  button for 5 seconds to turn off the indicator light.

Load the Baskets



With delicate glasses and porcelain make sure they are labelled dishwasher-proof.

- × Do not put in the appliance items made of wood, horn, aluminium, pewter and copper.
- × Do not put in the appliance items that can absorb water (sponges, household clothes).
- ▶ Only use the appliance to wash items that are dishwasher-safe items.
- ▶ Remove the remaining food from the items.
- ▶ Soften burned food on the items before washing.
- ▶ Put hollow items (cups, glasses and pans) with the opening down.
- ▶ Put items with deep hollows in a slanted position.
- ▶ Mix spoons with other cutlery to prevent them from bonding together.
- ▶ Make sure that cutlery and dishes do not bond together and that there is a gap between each item.
- ▶ Make sure that glasses do not touch other glasses.
- ▶ Put small items in the cutlery basket.
- ▶ Put light items in the upper basket. Make sure that the items do not move.
- ▶ Make sure the spray arms can move freely before starting a program.



If collision noises are heard during a program run: Check that the dishes and glassware have a firm position.

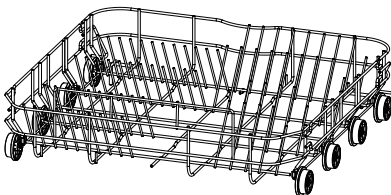

Place heavily soiled items (like pots and pans or dinner plates) in the bottom basket. The more powerful spray jet provides a better dishwashing result.

Upper baskets

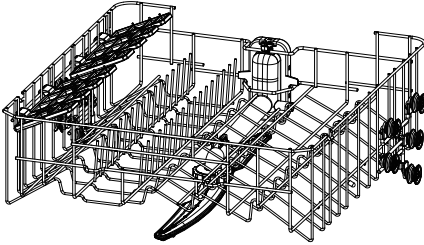

- ▶ The upper basket is designed to hold items like glasses, cups, saucers, plates, small bowls and shallow pans.

Adjusting the height of the upper basket

Adjust the height of the upper basket to make space for taller items. The basket must be empty before the height is adjusted. Both sides of the basket must be adjusted to the same height.

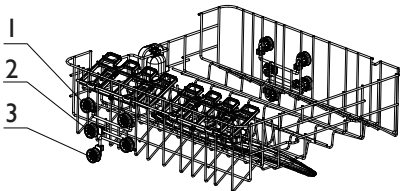

High position

When the middle shelf slide is in the assembly position of wheel 1 and wheel 2, the middle shelf is in the high position.

Low position

When the middle shelf slide is in the assembly position of wheel 2 and wheel 3, the middle shelf is in the low position.

Foldaway cup racks

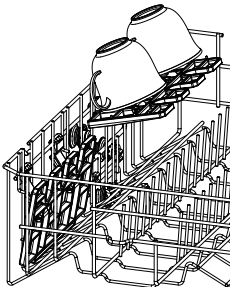

The cup racks can be folded or opened according to needs. When opened, tea cups can be placed on top, and folding can save space for other items.

Lower basket

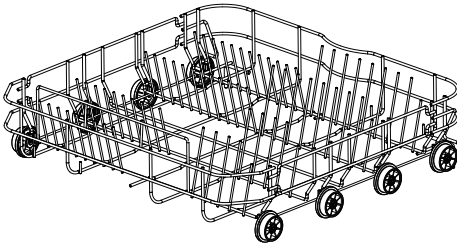

- ▶ Place the largest items here: pots, pans, lids, serving dishes and bowls.
- ▶ Ensure dishware items do not block the spray arm above from rotating.
- ▶ If you need more height for tall items, you can raise the upper basket. See instructions on previous pages.

Cutlery basket

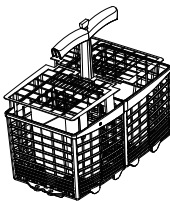

- ▶ Mix spoons with other cutlery to prevent them to bond together.
- ▶ Use the grid element in order to separate the cutlery.
- ▶ Place cutlery with the handles down for better washing results.
- ▶ If long items may block the spray arm find a horizontal positioning in the upper basket.

CAUTION!



Put sharp and pointed items with the blade pointing downward to keep them out of harm's way.

Detergent



Please use only a dedicated dishwasher detergent and follow the related instructions and dosage on its package.

Using powder detergent

For powder detergent quantities, refer to the following 'Powder detergent quantity recommendations' table and the detergent manufacturer's guidance. No detergent is needed for a rinse cycle.

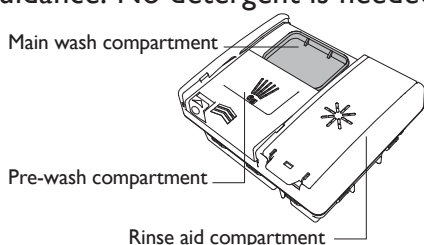

Check that the dispenser is empty and dry. Add powder detergent or tablets to the detergent dispenser.

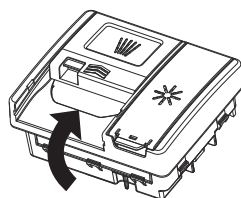

Remove any excess detergent then slide the cover closed. It will click into place. If required, add additional detergent to the pre-wash compartment on top of the dispenser.

When washing heavily soiled dishware in hard water, more detergent may be required. Refer to 'Powder detergent quantity recommendations'.

Multitabs

These Multitabs detergent tablets could include two different agents for water softening, rinse aid and other functions. The softener and rinse aid settings must be adjusted according to section BEFORE FIRST USE. Usually the default setting performs well. If there are streaks, stains, shimmer etc., refer to section TROUBLESHOOTING and BEFORE FIRST USE.





Detergent tablets do not fully dissolve with short programs. That may cause bad washing results and detergent residues.

If detergent without multifunction should be used again:

1. Save 3 to 5 tablets.
2. Adjust the softener and rinse aid setting according to section BEFORE FIRST USE.
3. Use Multitabs detergent tablets for the next 3 to 5 wash cycles.

Start a Program

1. Close the door.
2. Press the ON/OFF button .
3. Press the program button you want to select and then the required program indicator flashes.
Additionally the display shows the program run-time.
4. If need select a start time for a delayed start, refer to the section **START A PROGRAM WITH DELAY**.
5. Press the START/PAUSE button  to activate the program or the delay start.
The program starts. The display acts now as a countdown of the remaining run-time.



The appliance remembers the last programme you used. The next time the appliance is switched on, the appliance pre-selects the programme used last time.

Interrupt a Running Program

To interrupt a running program:



- ▶ Press the START/PAUSE button . The displayed cycle time is flashing.
- ▶ Open the door.

To continue a paused program:

Close the door and press the button  to continue the program from the point of interruption. To prevent poor wash performance, do not leave the door open for a long time.

Start a Program with Delay

Set a start time by the following procedure in order to delay a program start:

1. Set a program.
2. Press the reservation button  until the display shows the required delay time (from 1 to 24hours).
3. Press the START/PAUSE button .
 - ▶ The display shows the countdown of the start delay.
 - ▶ When the countdown is completed, the program starts.

Cancel a Delayed Start

When the current reservation time is displayed for 24 hours, press the reservation  button again to cancel the reservation. Afterwards, the display shows the duration time for the set program.

Cancel Start Delay Program

Press the ON/OFF button  for about 1 second.

- ▶ The start delay is cancelled.
- ▶ The program is aborted.
- ▶ The appliance is switched off.

Start a new program and a delayed start if needed.



CAUTION!

If a program is aborted in the process of washing dishes, the residue of detergent remains on the dishes. These can cause damage to health. Make sure to rinse off the detergent residues completely before using these dishes again.



If the door is opened immediately after the end of program, hot steam can escape. The danger of scalding. Open the door carefully.



Make sure that there is detergent in the detergent dispenser before starting a new program.

Cleaning the filter, spray arms and filter plate

Disconnect the dishwasher from the power supply and allow it to cool before undertaking any cleaning or maintenance.

We recommend that the drain filter and filter plate be removed and cleaned once a month or whenever there is evidence of food particles. The spray arms in normal use should require cleaning less frequently. Lower and upper spray arms can be shaken to remove any foreign material, cleaned in hot water, and then rinsed in clean water.

The dishwasher must be used with the filter plate, drain filter and spray arms correctly in place. If using a dishwasher cleaner or descaler, refer to manufacturer instructions.

Removing and cleaning the filter

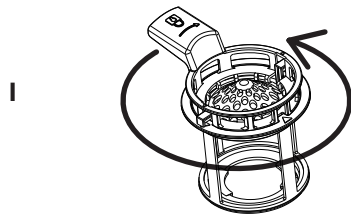

Twist the filter anticlockwise to release. Lift to remove.

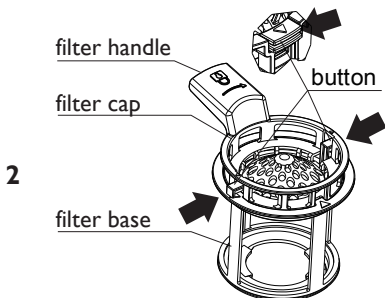

Twist the filter handle anticlockwise to release. Lift to remove from the filter plate. Separate the filter cap from the base by pressing the release buttons and lifting. Remove the filter plate gently from the locating clips at the rear of the drain. Do not attempt to remove the filter by force as this may cause damage. Clean under hot water and rinse thoroughly.

Replacing the filters:

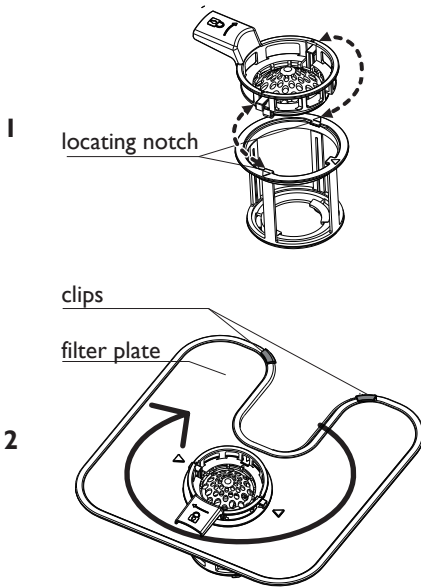

1. Align the filter cap with the notch on the filter base for one side.
2. Press the button to clip the filter cap under the filter base locating notches for the other sides.
3. Slot the filter plate under the locating clips at the rear of the drain and push firmly back into the clips. Ensure the filter plate is flush with the dishwasher base.
4. Place the drain filter back into the dishwasher base. Rotate the filter handle clockwise to click into place.

Care and Cleaning of the Spray Arms

Spray arms should be regularly inspected for dirt. If needed the spray arms could be removed.

Cleaning the Upper spray arm

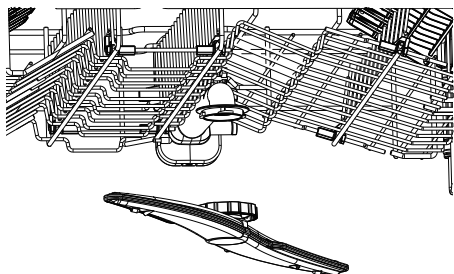

To remove the upper spray arm, turn the locking nut clockwise to release. Rinse the spray arm thoroughly under running water, then refit.

Cleaning the lower spray arm

To remove the lower spray arm, lift it from the base of the dishwasher. Rinse the spray arm thoroughly under running water, then refit. Ensure the arm rotates freely when refitted.

External Cleaning



CAUTION!

Never clean the appliance with a steam cleaner.

Never use bleach or other chlorinated detergents.

- ▶ Clean the appliance with a damp soft cloth.
- ▶ Only use neutral detergents. Do not use abrasive products, abrasive cleaning pads or solvents.
- ▶ Clean the door seal with a damp soft cloth.



Many occurring problems could be solved by yourself without specific expertise. In case of a problem please check all shown possibilities and follow below instructions before you contact an after-sales service.



CAUTION!

- ▶ Before maintenance, deactivate the appliance and disconnect the power plug from the power socket.
- ▶ Electrical equipment should be serviced only by qualified electrical experts, because improper repairs can cause considerable consequential damages.

The appliance does not start, or it stops during operation

Problem	Possible cause	Possible solution
The program does not start.	The appliance door is open.	Close the appliance door.
	Delay start is set.	Refer to displayed time.
	Power plug is not connected in the power socket.	Connect the power plug.
	Fuse in the house circuit is damaged.	Replace the fuse.
Rinse Aid Indicator  is light.	Rinse aid dispenser is empty.	Press and hold the  button for 5 sec after each refill.

Error codes on the display

Acoustic alarm, display shows ALARM CODE <i>A10</i> The appliance does not fill with water.	The water tap is closed.	<ul style="list-style-type: none"> • Open the water tap. Note: Whenever Error 'A10' is solved switch off the appliance and restart the program.
	The water inlet hose has a kink or a bend.	Make sure that the position of the hose is correct.
	In case of aqua-stop system: water protection is triggered; the marker (C) is red.	The hose must be replaced.
	Filter in the water inlet hose is clogged.	Clean the filter at the inlet hose connections at tap and the rear of the appliance.
	Water inlet is clogged.	Check the water flow from the tap
	Water pressure is too low.	Contact your local water authority.

Problem	Possible cause	Possible Solution
Acoustic alarm, display shows ALARMCODE F30 Leak: The drain pump runs permanently.	<ul style="list-style-type: none"> Anti-flood device is on: There are water leakages in the appliance. The water inlet valve is open and blocked. The drainage is blocked. 	<ul style="list-style-type: none"> Close the water tap. Disconnect the appliance from the power supply. Contact Service.

Washing Results are not satisfactory

The dishes are not clean.	Filters are clogged.	Clean the filters.
	Filters are not correctly assembled and installed.	Make sure that the filters are correctly assembled and installed.
	Spray arms are clogged.	Remove remaining food remnants with a thin pointed object.
	Program was not applicable for the type of load and food remnants.	Make sure that the program is applicable for the type of load and food remnants.
	Incorrect position of the items in the baskets. Water could not wash all items.	Make sure that the position of the items in the baskets is correct and that the water can easily wash all items.
	Spray arms could not turn freely.	Make sure that the position of the items in the baskets is correct and does not cause the blockage of the spray arms.
	No detergent or insufficient quantity of detergent in the detergent dispenser.	Make sure that you add the correct quantity detergent in the dispenser before you start a program.
Whitish streaks, stains or bluish layers on glasses and dishes.	The wash cycle was interrupted by a long break.	Do not open the door or cut power supply during the wash cycle.
	The released quantity of rinse aid is too much.	Decrease the released quantity of rinse aid. Refer to section DIFFERENT SETTINGS FOR RINSE AID.
	The quantity of detergent was too much.	Make sure that you add the correct quantity of detergent in the dispenser before you start a program.
	Multitab detergent tablets used with a short program might not fully dissolve.	Select a longer program when using Multitab detergent tablets.

Problem	Possible cause	Possible Solution
Dry water drop stains on glasses and dishes.	Rinse aid dosage is too low.	Increase the released quantity of rinse aid. Refer to section DIFFERENT SETTINGS FOR RINSE AID.
	Quality of rinse aid or Multitab.	Cleaning product too old, change the product.
The dishes are wet.	<ul style="list-style-type: none"> • Program had no drying phase. • Program had a low temperature drying phase. 	Open the door slightly and leave it ajar (about 100 mm) to help the drying process.
The dishes are wet and matte.	Rinse aid dispenser is empty.	Refill rinse aid into the dispenser and reset the rinse aid indicator.
	Quality of rinse aid or Multitab.	Cleaning product too old; change the product.



Economic and Environmental Use

- ▶ It is not recommended to pre-rinse the dishes under running water.
- ▶ Select the washing programs by type and degree of contamination of the dishes.
- ▶ Select the economic mode program ECO for normal soiled items.
- ▶ The most economical use you will have with full loading.
- ▶ Only use the manufacturer's recommended detergent or rinse aid dosages.

We recommend our Haier Customer Service and the use of original spare parts.

If you have a problem with your appliance, please first check TROUBLESHOOTING.

If you cannot find a solution there, please contact:

- ▶ Your local dealer.
- ▶ The Service & Support area at www.haier.com.au
or at www.haier.co.nz

where you can activate the service claim and also find FAQs.

To contact our Service, ensure that you have the following data available. The information can be found on the rating plate at the door.

Model _____

Serial No. _____

Standards test information

Standards test information can be viewed online by going to www.haier.com.au or www.haier.co.nz and search your model code.

Please read this warranty card carefully. Attach your purchase receipt to this warranty card and keep in a safe place. You must produce both warranty card and proof of purchase in the event of a warranty repair being required.

When you purchase any new Haier Product you automatically receive a two year Manufacturer's Warranty covering parts and labour for servicing.

The Manufacturer undertakes to:

Repair or, at its option, replace without cost to the owner either for material or labour any part of the Product, the serial number of which appears on the Product, which is found to be defective within TWO YEARS from the date of purchase.

This warranty DOES NOT cover:

- A Service calls which are not related to any defect in the Product. The cost of a service call will be charged if the problem is not found to be a Product related fault. For example:
 1. Correct the installation of the product.
 2. Provide Instruction on use of the product or change the setup of the product.
 3. Replace house fuses or correct house wiring.
 4. Correcting fault(s) caused by the user.
 5. Noise or vibration that is considered normal.
 6. Water on the floor due to incorrect loading or excessive suds.
 7. Blocked pumps, removal of foreign objects/substances from the machine, including the pump and inlet house filters.
 8. Correcting damage caused by pests, eg. rats, cockroaches etc.
 9. Correct corrosion or discolouration due to chemical attack.
 10. Power outages or surges.
- B Defects caused by factors other than:
 1. Normal domestic use or
 2. Use in accordance with the Product's User Guide.
- C Defects to the Product caused by accident, neglect, misuse or 'Act of God'.
- D The cost of repairs carried out by non-authorized repairers or the cost of correcting such unauthorised repairs.
- E Normal recommended maintenance as set out in the Product's User Guide.
- F Repairs when the appliance has been dismantled, repaired or serviced by other than an AUTHORISED CUSTOMER SERVICE CENTRE or the selling dealer.
- G Pick up and delivery.
- H Transportation or travelling costs involved in the repair when the product is installed outside the AUTHORISED CUSTOMER SERVICE CENTRE'S normal service area.

This product has been designed for use in a normal domestic environment. It is not intended for commercial use. Doing so may affect product warranty.

Service under this warranty must be provided by an Authorised Service Repairer (refer to the Customer Care section for contact details). Such service shall be provided during normal business hours. This warranty certificate should be shown when making any claim.

Note:

This Warranty is an extra benefit does not affect your legal rights and applies only to products purchased in New Zealand and Australia. **Please keep this Warranty Card in a safe place.**

For Australian customers:

Our goods come with guarantees that cannot be excluded under the Australian Consumer Law. You are entitled to a replacement or refund for a major failure and for compensation for any other reasonably foreseeable loss or damage. You are also entitled to have the goods repaired or replaced if the goods fail to be of acceptable quality and the failure does not amount to a major failure.

Customer Care

Check the things you can do yourself.
Refer to your User Guide and check:

- 1 Your appliance is correctly installed.
- 2 You are familiar with its normal operation.
- 3 You have read the problem solving section in your User Guide.

If after checking these points you still need assistance, please refer to your nearest Haier Authorised Repairer.

In New Zealand, if you need assistance...*

Call your retailer who is trained to provide information on your appliance, or if we can be of any further help, please contact our Customer Care Centre:

Toll Free: 0800 242 437 **Fax:** (09) 273 0656

Email: customer.care@haier.co.nz

Postal address: P.O. Box 58732, Botany, Manukau 2163

If you need service...*

We have a network of independent Fisher & Paykel Authorised Repairers whose fully trained technicians can carry out any service necessary on your appliance. Your dealer or our Customer Care Centre can recommend a Fisher & Paykel Authorised Repairer in your area.

In Australia, if you need assistance...*

Call the Customer Care Centre and talk to one of our Customer Care Consultants.

Toll Free: 1300 729 948 **Fax:** (07) 3826 9298

Email: customer.care@haierlife.com.au

Postal Address: PO Box 798, Cleveland QLD 4163

If you need service...*

We have a network of qualified Authorised Repairers whose fully trained technicians can carry out any service necessary on your appliance. Our Customer Care Centre can recommend an Authorised Repairer in your area.

*If you call or write, please provide: name, address, model number, serial number, date of purchase and a description of the problem. This information is needed in order to better respond to your request for assistance.

Product Details

Model ----- **Serial No.** -----

Date of Purchase ----- **Purchaser** -----

Dealer ----- **Suburb** -----

Town ----- **Country** -----

Thank you for choosing Haier. We are confident that you will enjoy many years of good service from your appliance.

条形码尺寸40*8mm，由厂家生成。

432921A 0120507036